

WINNISTM FEED

ADVANCED MACHINING

EXTENDED THRU
OCTOBER

2024 PROMO

MARCH - JULY

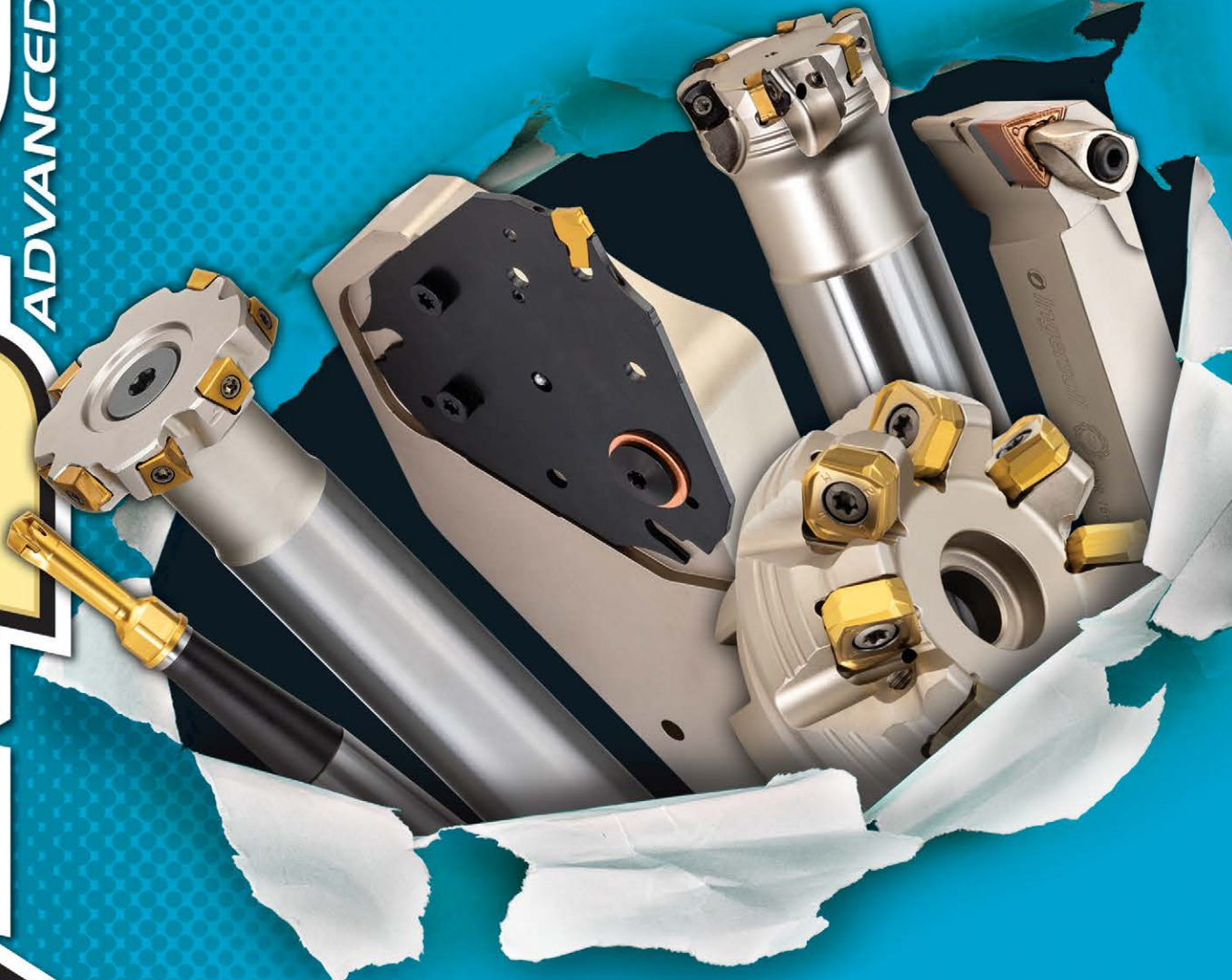

Member IMC Group
Ingersoll
Cutting Tools

MAXSPEED™

90° End Mill, Face Mill, and Slotters With High Feed Rate Capability

- ▶ Strong double-sided, 4-edge, tangential insert with helical cutting edges for smooth machining.
- ▶ Exact 90° shouldering with straight and helical ramping capabilities.
- ▶ Secure dovetailed insert seating for maximum stability.
- ▶ New slotting heads featuring rigid tri-lobe connection.

PURCHASE	
10 inserts per pocket	PC 403
RECEIVE	
corresponding body FREE	



NUMAX ILOCK™

Extended Flute End Mills and Shell Mills with New, Smaller-Size Interlocking Inserts for Smooth Operation

- ▶ Overlapping "V-Notch" inserts that allow for smooth chip formation at high feed-rates.
- ▶ Smaller inserts designed for lower HP machines, freer cutting conditions, and larger radial depth of cut in aggressive materials.
- ▶ Patented end station design with available corner radii inserts from .031" to .250" with no cutter body modifications needed.

PURCHASE*	
one fill (rounded up to nearest pack size)	PC 407
RECEIVE	
corresponding body at a 50% discount	

*11 mm insert only



GOLDSPEED™

Our Most Popular Hi-Feed Mill is Expanded to include 4, 6, and 16 mm Cutter Series

- ▶ Hi-feed, high-positive designed 4-corner insert with wiping flats that can eliminate secondary passes.
- ▶ Inserts feature 12° lead-angles to produce 5x the feed rates in any material.
- ▶ Inserts include multiple types of edge reinforcement and corner configurations.

PURCHASE*

10 inserts per pocket

RECEIVE

corresponding body **FREE**

PC
406

*4, 6, and 16 mm inserts only

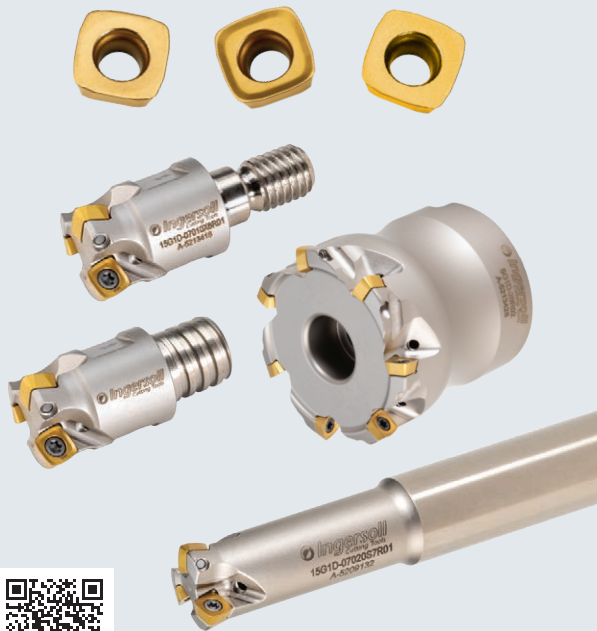

HIPOSWINV™

Aero-centric Router/Shoulder/Hi-Feed Mills With V-Bottom Inserts for Secure Clamping

- ▶ Ingersoll's newest, highest positive geometry featuring balanced cutters for high RPM - ideal for aerospace materials.
- ▶ Steep concave face accommodates aggressive aluminum router ramp angles.
- ▶ 90° inserts with integrated wiper flats produce 32-63 Ra deck finishes, and hi-feed inserts.

PURCHASE

10 inserts per pocket

RECEIVE

corresponding body **FREE**

PC
400

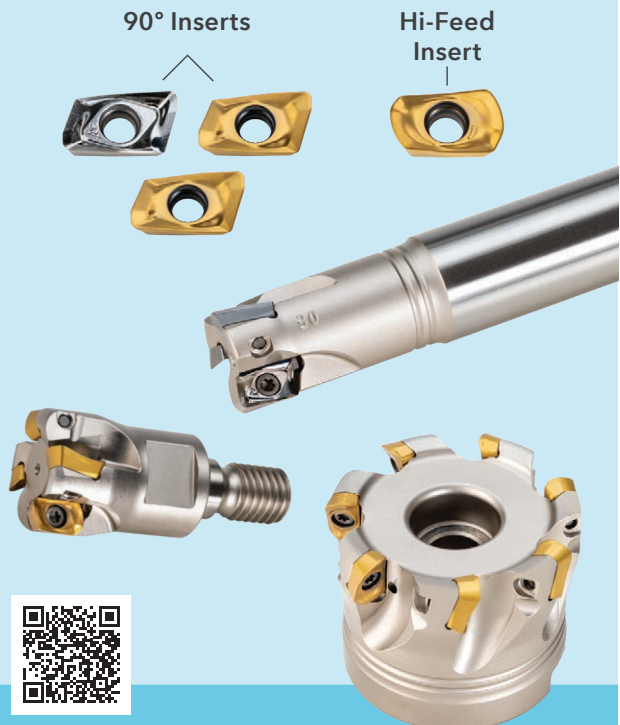

DIFEEDWINV™

Next-Gen Hi-Feed Performance, With New V-Bottom Clamping

- ▶ V-bottom clamping for super secure performance.
- ▶ Insert designed with higher ramping angle for more flexibility.
- ▶ 4 cutting edges per insert offer great economy.
- ▶ Higher cutter densities deliver great productivity.

PURCHASE	PC 401
10 inserts per pocket	
RECEIVE	
corresponding body FREE	



DIPOSQUAD™

True 90° Shoulder Mills With 8-Edge Economy, Now Featuring New 10 mm Insert Size

- ▶ High axial rake reduces cutting loads and promotes smooth machining.
- ▶ Unequally spaced insert placement aids to diffuse vibration.
- ▶ Integrated wiper flats produce 32-63 Ra finishes.

PURCHASE*	PC 402
10 inserts per pocket	
RECEIVE	
corresponding body FREE	
*10 mm insert only	

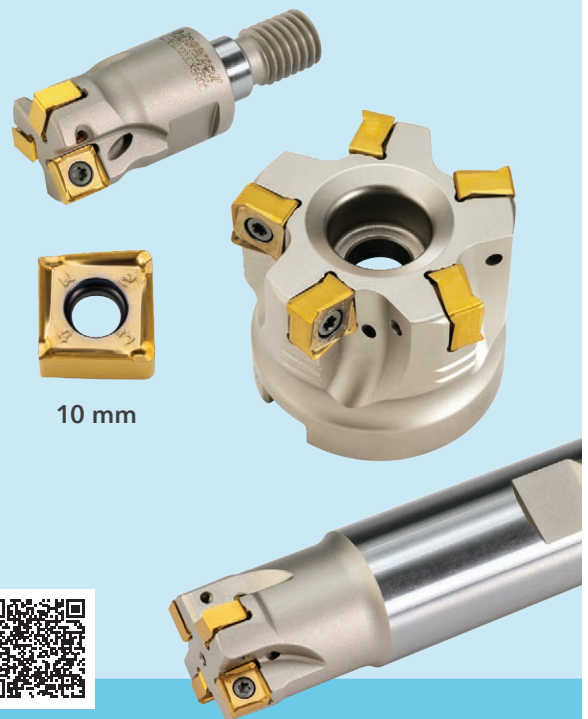

DIPOSQUADF™

45° and Hi-Feed Face Mills That Share the Same High-Strength, 8-Edge Insert

- ▶ Extreme geometry enjoys heavy feed rates and promotes efficient chip evacuation.
- ▶ Offered with 2 insert IC sizes for depth-of-cut and density diversity.
- ▶ Integrated wiper flats produce 32-63 Ra finishes.

PURCHASE

10 inserts per pocket

RECEIVE

corresponding body **FREE**

PC
404



11 mm



14 mm



20°



45°



CERASPEED™

New, Smaller, 6 mm Ceramic Hi-Feed Insert for Exceptional Productivity

- ▶ Double-sided, dimple type inserts with 4 cutting edges.
- ▶ Dimple style inserts and top clamp holder design provide multi-directional clamping force.
- ▶ Smaller insert allows for smaller cutter diameters and higher insert densities.
- ▶ SiAlON grade IN76N allows cutting speeds up to 36 times greater than solid carbide.

PURCHASE*

10 inserts per pocket

RECEIVE

corresponding body **FREE**

PC
402

*6 mm insert only

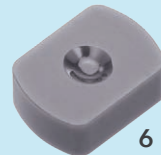

6 mm



TWIST SPEED™

New 8xD Bodies, Diameter Range Expansion, and Flat Bottom Tips

- ▶ New, larger diameter range: 0.4724-1.0197" (12.0-25.9 mm).
- ▶ New, 8xD body expansion added to existing 3xD and 5xD bodies.
- ▶ Self-centering geometry for excellent hole precision and surface finish.
- ▶ Quick-change clamping system reduces downtime.

PURCHASE		PC 409
6 tips - any geometry		
RECEIVE		
corresponding body (up to 8xD) FREE		

FPF (Flat Bottom)



Shanks:
3xD
5xD
8xD



FPC (Self-Centering)



WINTWIST™

Modular Quick Change Drilling with TopOn (M12) Adaption

- ▶ Accommodates a wide range of applications using the TopOn (M12) connection.
- ▶ Simplified set-up for Multi-Spindle and Swiss-type machines.
- ▶ Compatible with existing GoldTwist tips.
- ▶ Coolant thru.

PURCHASE		PC 412
6 GoldTwist tips		
RECEIVE		
corresponding WinTwist (TopOn/M12) body at a 50% discount		

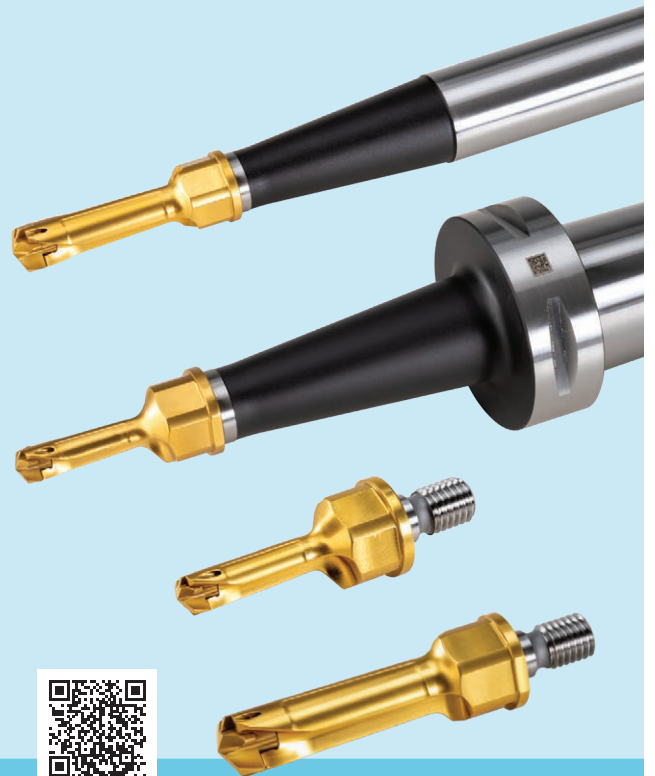

GOLD TWIST™

New Small Diameter Quick Change Drills

- ▶ Improved productivity and reduced cost for 4.0-5.9 mm diameters.
- ▶ Tips supplied in special preloaded wrench for fast and simple replacement.

PURCHASE*		
6 TPA tips		PC 410
RECEIVE		
corresponding body FREE		
*4.0-5.9 mm diameters only		



GOLD TWIST™

Premium Hole Machining With Unique, Self-Centering TPC Geometry

- ▶ Self-centering geometry eliminates piloting for increased productivity in steel and cast iron.
- ▶ Excellent surface finish, hole cylindricity, and straightness.
- ▶ Diameter range: 0.236-1.020" (6.0-25.9 mm)

PURCHASE		
6 TPC self-centering tips		PC 411
RECEIVE		
corresponding body (up to 8xD) at a 50% discount		



SPADETWIST™

New Self-Centering Geometry for Large Diameter Applications

- ▶ Eliminates the need for piloting for 8xD applications.
- ▶ Excellent accuracy and phenomenal surface finish.
- ▶ Improves cylindricity and straightness.
- ▶ Unique rigid, quick change clamping system.

PURCHASE	
6 tips - any geometry	PC 413
RECEIVE	
corresponding body (up to 8xD) at a 50% discount	



SOLIDDRILL³™

3-Flute Solid Drills Expanded to 8xD Depth and New Flat Bottom Geometry

- ▶ 3-flute design allows up to 50% higher feed rates.
- ▶ Flat bottom geometry ideal for drilling cavities in bolt holes.
- ▶ Self-centering geometry eliminates need to pilot up to 8xD.

PURCHASE	
4 drills - any style	PC 408
RECEIVE	
5th drill FREE*	
*Item of equal or lesser value	

Flat Bottom Geometry (FF) Standard Point Geometry (FR)

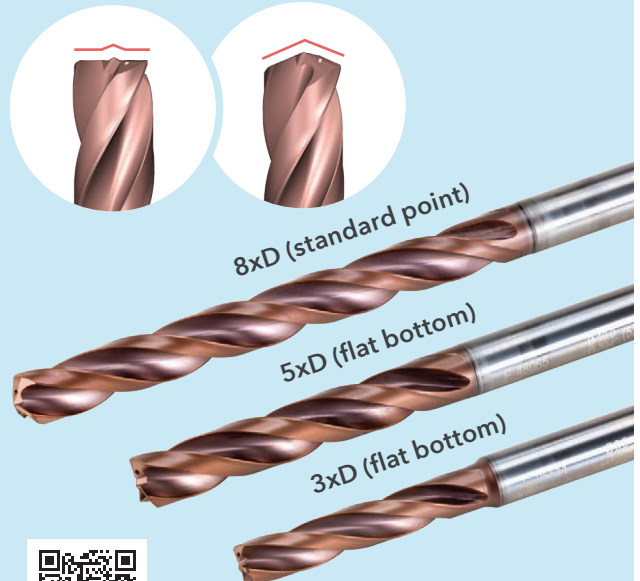

WINTURN™

6-Edge Inserts and Holders for All-Directional and Hi-Feed Turning

- ▶ Multi-directional turning applications including backward and forward longitudinal turning and facing.
- ▶ Hi-feed capabilities; up to .047 ipr when backward turning.
- ▶ Serrated cutting edge enables excellent chip control at a variety of cutting depths.
- ▶ Optimally designed negative (double-sided) insert with 6 cutting edges.
- ▶ When mounted to the holder, WinTurn features the same axial and radial rake angle as standard positive inserts, lowering cutting forces.

TNMV-BS
(for stainless steel)



TNMV-BM
(for steel)



PURCHASE

20 inserts

RECEIVE

external holder **FREE**

PC
414A

PURCHASE

30 inserts

RECEIVE

CoolBurst holder **FREE**

PC
414B



Coolant Thru



FLEXTURN™

Time-saving Modular Head and Holder System for Swiss Machines

- ▶ Improved productivity due to reduced set-up time.
- ▶ Rigid clamping between shanks and heads, and excellent repeatability.
- ▶ Reduced inventory due to the ability to mount multiple heads on one shank.

PURCHASE

one shank and 10 inserts

RECEIVE

corresponding head **FREE**

PC
415A

PURCHASE

one shank and 20 inserts

RECEIVE

corresponding CoolBurst head **FREE**

PC
415B

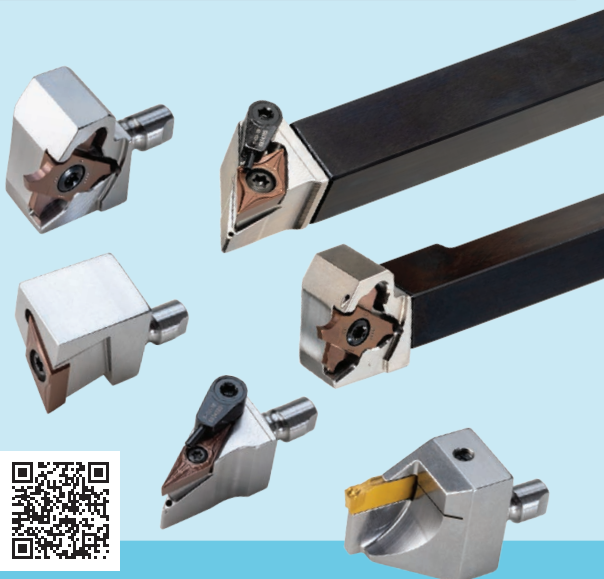

MULTITURN™

VBMX Insert and Holders With Rigid Clamping

- ▶ 35° inserts and holder system for precision machining.
- ▶ Groove on insert bottom prevents insert from moving in the pocket (when used with LVJBR holders).
- ▶ Simple, screw-held clamping.

PURCHASE

20 inserts

RECEIVE

corresponding LVJBR/L external holder **FREE**

PC
417

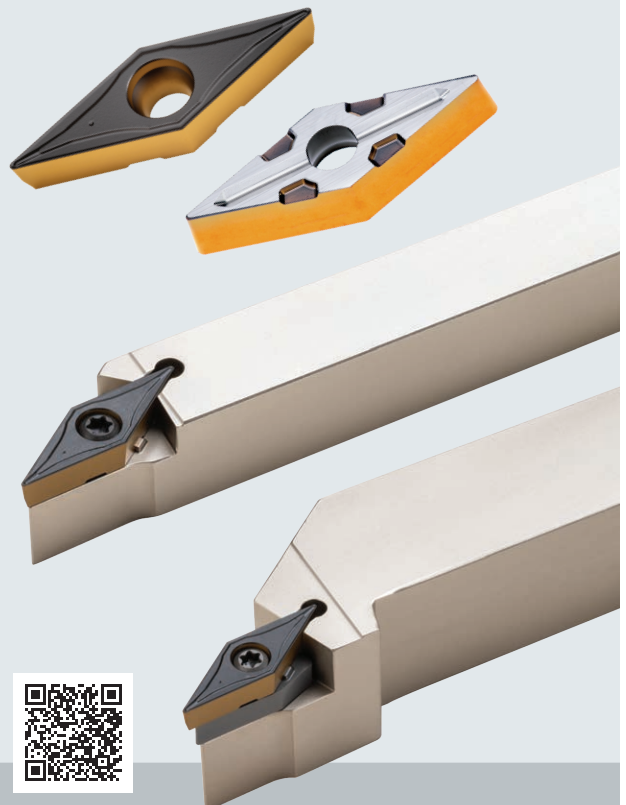

WINCUT™

Single-Ended Rigid Inserts and Holders for Parting and Deep Grooving with Unique Adapters

- ▶ Stable insert clamping with 3-point contact area.
- ▶ Very rigid triangular blades and dedicated holders with thru-coolant.
- ▶ Improved productivity due to hi-feed machining capability.
- ▶ Straighter cuts, better surface finish, longer tool life.

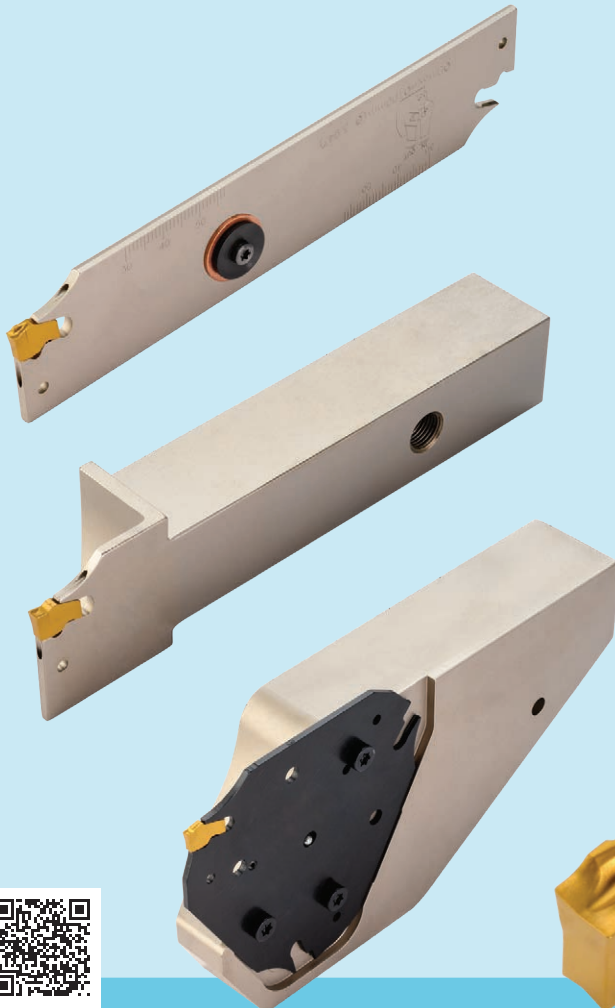

PURCHASE

one block and 10 inserts

RECEIVE

triangle blade **FREE**

PC
416A

PURCHASE

one block and 20 inserts

RECEIVE

CoolBurst triangle blade **FREE**

PC
416B

PURCHASE

20 inserts

RECEIVE

traditional blade or square shank holder **FREE**

PC
416C

PURCHASE

40 inserts

RECEIVE

CoolBurst traditional blade or square shank holder **FREE**

PC
416D

SFJ

SFC

Ingersoll Cutting Tools reserves the right to limit quantities, to change the terms of the promotion without notice, and to refuse an order that does not conform with the terms and conditions contained or implied herein. Offer good March 1, 2024 through October 31, 2024, unless otherwise noted, or while supplies last. Prices exclude applicable taxes. All promotions based on the price list in effect at the same time the order is placed. Distributor orders must be drop shipped to the end user. Limit of 5 of the same product to the same end user.

Marketing & Technology Center
845 South Lyford Road
Rockford, IL 61108-2749 U.S.A.
Tel: 815/387-6600
E-mail: info@ingersoll-imc.com
www.ingersoll-imc.com

Ingersoll Cutting Tools Canada
845 South Lyford Road
Rockford, IL 61108-2749 U.S.A.
Tel: 800/892-6859

Ingersoll Cutting Tools de México S.A. de C.V.
Jose Musa de Leon, No. 2411, Locales 6 y 7
Fracc. Residencial los Pinos
Saltillo, Coahuila C.P. 25198, México
Tel: 52-844-4-85-32-20

TM
WINN
ADVANCED MACHINING

Member IMC Group
Ingersoll
Cutting Tools